

Specifications

In-wall cabinet:	Steel, zinc coated
Front:	2-piece front, frame with door <ul style="list-style-type: none"> • adjustable depth • white powder coated RAL 9016 • with latch
Sides:	80mm, with multi punching
Floor piece:	adjustable depth, white powder coated
Feet:	steel reinforced, height adjustable

In-wall cabinets TT-VS packed in 2 units. The front can be stored safe, until finishing. Two manifold rails included.

	Type	TT-VS 3/300	TT-VS 4/400	TT-VS 5/500	TT-VS 7/600	TT-VS 9/750	TT-VS 12/900	TT-VS 14/1050	TT-VS 17/1200	TT-VS 20/1500	
B	Width	385 mm	435 mm	490 mm	575 mm	725 mm	875 mm	1025 mm	1175 mm	1475 mm	
	Height	700 - 800 mm									
	Depth	80 - 120 mm									
F	Front	410 mm	460 mm	515 mm	600 mm	750 mm	900 mm	1050 mm	1200 mm	1500 mm	
G	Door	340 mm	390 mm	445 mm	530 mm	680 mm	830 mm	980 mm	1130 mm	1430 mm	
	Space in mm	405x730	455x730	510x730	595x730	745x730	895x730	1045x730	1195x730	1495x730	
	Art-Nr.	4603	4604	4605	4607	4609	4612	4614	4617	4620	

B = Width In-wall cabinet F = Front G = Door

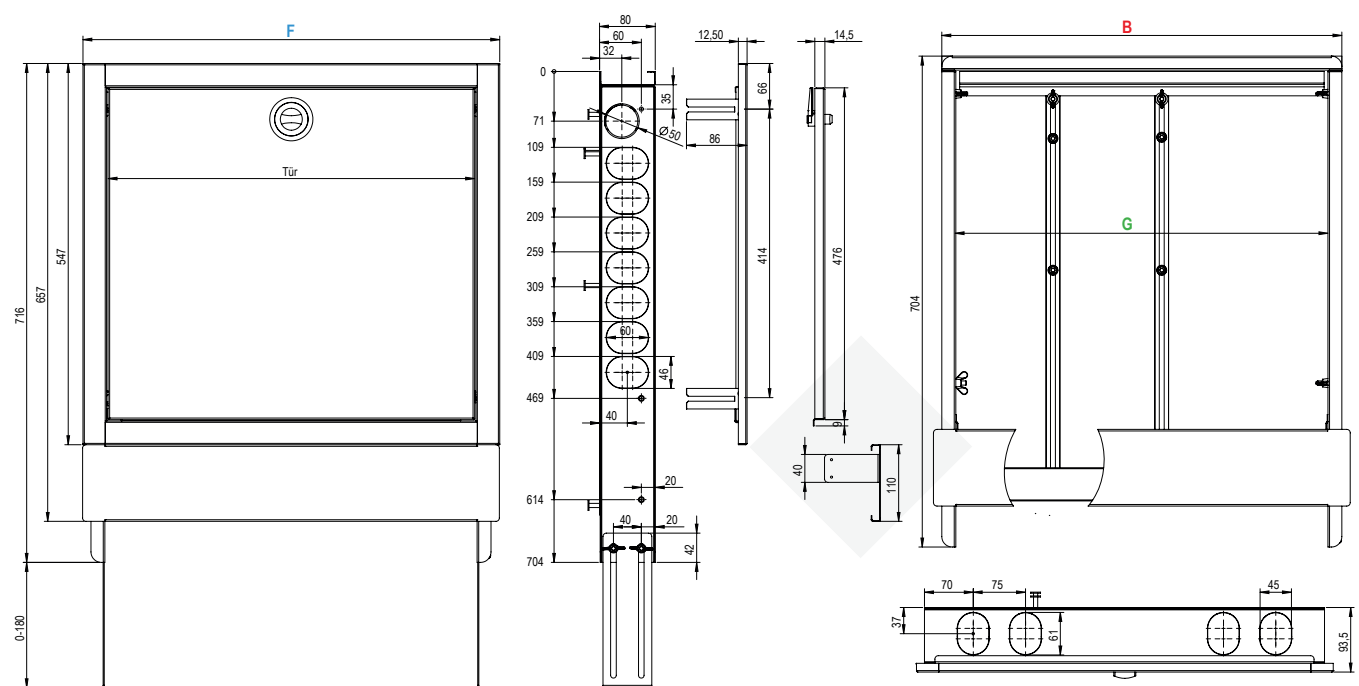

Cabinet / manifold combination sizes TT-VS-110T, TT-VS-80T, D-VS-110T, D-VS-80T, TT-VS-A

TYPE		300	400	500	600	750	900	1050	1200	1500
IN-WALL		D-VS TT-VS 3/300	D-VS TT-VS 4/400	D-VS TT-VS 5/500	D-VS TT-VS 7/600	D-VS TT-VS 9/750	D-VS TT-VS 12/900	D-VS TT-VS 14/1050	D-VS TT-VS 17/1200	D-VS TT-VS 20/1500
ON-WALL		X	TT-VS-A 400	TT-VS-A 500	TT-VS-A 600	TT-VS-A 750	TT-VS-A 900	TT-VS-A 1050	TT-VS-A 1200	X

CONNECTING SET	CABINET TYPE	ASSEMBLED	CIRCUITS									
TT-AGEw 1" ArtNr. 5002	110T	xxxx104										
	80T	xxxx108	2	3	4 - 5	6	7 - 9	10 - 12	13 - 15			
	A	xxxx112										
TT-AGEw 3/4" ArtNr. 5022	110T	xxxx103										
	80T	xxxx107	2	3	4 - 5	6	7 - 9	10 - 12	13 - 15			
	A	xxxx111										
TT-AGEs 1" ArtNr. 5102	110T	xxxx102										
	80T	xxxx106	2	3	4	5	6 - 8	9 - 11	12 - 14			
	A	xxxx110										
TT-AGEs 3/4" ArtNr. 5122	110T	xxxx101										
	80T	xxxx105	2	3	4	5	6 - 8	9 - 11	12 - 14			
	A	xxxx109										
TT-WMZw 3/4" ArtNr. 5013	110T	xxxx203										
	80T	xxxx207			2	3 - 4	5 - 7	8 - 10	11 - 13			
	A	xxxx211										
TT-WMZc 3/4" ArtNr. 5012	110T											
	80T				2	3 - 5	6 - 8	9 - 11	12 - 14			
	A											
TT-WMZw 1"-110 ArtNr. 5014	110T	xxxx204										
	80T	xxxx208				2 - 3	4 - 6	7 - 9	10 - 12	13 - 15		
	A	xxxx212										
TT-WMZs 3/4" ArtNr. 5033	110T	xxxx201										
	80T	xxxx205		2	3	4 - 5	6 - 8	9 - 11	12 - 14			
	A	xxxx209										
TT-WMZr 3/4" ArtNr. 5035	110T											
	80T			2	3	4 - 5	6 - 8	9 - 11	12 - 14			
	A											
TT-WMZs 1"-110 ArtNr. 5034	110T	xxxx202										
	80T	xxxx206		2	3	4 - 5	6 - 8	9 - 11	12 - 14			
	A	xxxx210										

110T = In-wall, depth 110-150mm Pre-assembled manifold stations
 80T = In-wall, depth 80-120 mm
 A = On-wall, depth 130 mm

